

# ORNAMENTAL FLOORS

## DESIGN AND INSTALLATION

### Introduction:

**O**rnamental floors, in all their varied forms, have become an increasingly popular choice for many consumers who want to customize their homes. The description “ornamental floors” covers a wide variety of options, some more difficult to execute than others. These include feature strips, patterned floors, hand-cut scroll work, laser-cut premanufactured inlays and borders, and mixed-media installations (involving metal, stone or tile with wood). An ornamental floor may be as simple as a single, 3/4-inch feature strip following the room’s perimeter. Or it may be ornate and elaborate, involving thousands of pieces that combine for a true work of art. The techniques used to create these flooring effects are as varied as the contractors who practice them.

This manual is intended for contractors both beginning and experienced. More experienced installers can use this to increase their command of wood flooring artistry. Newcomers to custom installations can learn

the basics of creating artistic wood flooring installations. However, it is important to have the proper knowledge about the tools required and how to use them before attempting custom work. (See “Tools Required,” page 5.) Also, while this publication will help the inexperienced installer learn some basic concepts about custom work, the best way to become proficient is by hands-on application of the techniques discussed.

Those wishing to become more proficient at installing ornamental floors might do so by working with an experienced custom installer, or by attending specialized seminars designed to teach custom techniques. The National Wood Flooring Association conducts such seminars periodically. Several NWFA members who have shared their skills at NWFA installation-training seminars and who have been honored with Floor of the Year Awards have lent their knowledge for this manual.

The contractor who develops a reputation for custom installations can become a craftsman and artist who is sought after. When a house guest comments on someone else’s hardwood floors, custom designs and inlays can transform the comment, “What beautiful wood floors!” to “Who did your hardwood floors, and how can I get in touch with them?” Referrals are the heart of any wood flooring business; ornamental and custom designs are certain to generate numerous referrals.



*The floor on the right is part of a renovation of a century-old home. Above, a recent installation. In either case, ornamental elements turn an already-striking hardwood floor into a work of art.*



# HISTORICAL PERSPECTIVE

**T**he prevalence of wood flooring in public places and private homes alike has made wood flooring something the eye often takes for granted. Thus when a floor has ornamental features, it is distinct and decorative.

Centuries ago, wood floors covered many of Europe's finest castles, estates and galleries — just as they cover so many homes, businesses and institutions today. The patterns in the floors were as much a work of art as the tapestries on the walls or the stained glass in the windows. Even those who toiled at sea may have made ornamental floors of the wooden decks of their ships, where the creation of a carving or inlay helped pass the many hours away from shore.

The ornamental floors of old were all hand-crafted and labor-intensive. The design was only one facet of the entire flooring process; the hand-scraping that followed was an art in itself.

The creative floors that were developed in Europe took their origins from marquetry, the technique of gluing veneers (very thin layers of wood) on top of solid wood or other veneers to create panel designs. Marquetry particularly flourished in the 17th century.

The European craftsmen who emigrated to North America brought with them their ideas and skills for the creation of handmade wood floor inlays and bor-

ders. Marquetry became parquetry when applied to the floor. But as in Europe, the labor-intensive trade limited its exposure in the 1700s and 1800s to only the homes of the wealthy. Thomas Jefferson's Monticello home offers examples of premier flooring of the period.

Flooring companies in the late 1800s and early 1900s were like any other segment of industrializing America. Manufacturers recognized that they needed to produce products both economically and efficiently, as broader markets developed amid growing cities.

Today, dozens of companies have stepped into that market — and dozens more specialize in various other aspects of decorative flooring. Power tools for sanding replaced the hand-scraping method in the 1930s, and other industry developments made artful floors more widespread.

Ornamental floors with distinctive designs are now more popular than ever. Even computers have made their way into the industry, with laser-cutting technology making inlays out of any design that can be drawn. Yet among all the technological advances are a handful of companies that still do their floor work the old-fashioned way — by hand and scroll saw. It is precisely this mix of honored practices and newer techniques that give equal credence to the variety of custom flooring options.



*These elaborate wood floors have graced the Hermitage in St. Petersburg, Russia, since the mid-1700s.*

# TYPICAL TOOLS OF A CUSTOM INSTALLER

The following list includes a variety of specialty tools that you may find helpful in tackling many ornamental flooring jobs. These tools are in addition to the basic tools you likely use on standard flooring jobs. A complete discussion of these basic tools can be found in *Tools of the Trade*, NWFA Technical Publication No. A300. To order copies, contact NWFA at the address and phone numbers listed on the back page of this publication.

For an ornamental flooring installer, the well-stocked tool box should include these items:

**ADHESIVE AND APPLICATOR** (wood glue and specialty adhesive.)

**BAND SAW**

**BEAM COMPASS OR TRAMMEL HEAD SET**

**BENCH OR TABLE SAW**

**BISCUIT CUTTER**

**BLOCK PLANE OR PALM PLANE** (hand-held)

**CHALK LINE** (assorted colors)

**CHISELS** (assorted widths)

**CLAMPS** (C-clamps, Pony or Quick-Grip, spring)

**COMPASS DIVIDER**

**COMPOUND MITER SAW**

**CORNER CHISEL**

**DOVETAIL SAW/BACK SAW**

**DRILL** (hand-held, variable-speed, reversible)

**DRILL BITS** (assorted sizes, brad-point, countersink)

**DRILL GUIDE** (for hand-held drill)

**EYE PROTECTORS** (safety glasses)

**HAMMER**

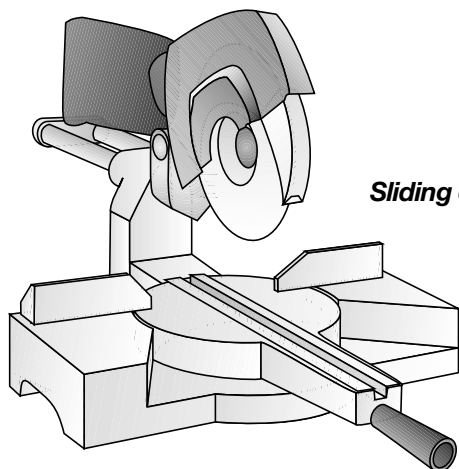

*Sliding compound miter saw.*

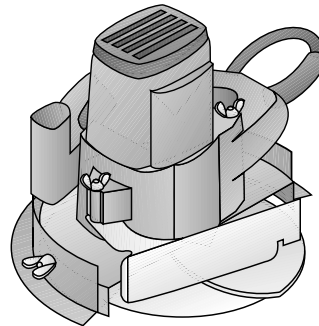

*Power jamb saw.*

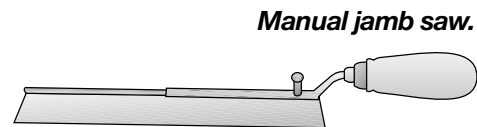

*Manual jamb saw.*

**HEARING PROTECTORS**

**MOISTURE METER**

**NAIL FINDER**

**NAIL PULLER/CUTTER**

**NAIL SETS**

**OFFSET SAW/JAMB SAW** (manual or power)

**PIN OR BRAD NAILER**

**PLATE JOINER**

**PLUMB BOB**

**PLUNGE ROUTER**

**PROTRACTOR**

**PRY BAR**

**RADIUS-CUTTING ATTACHMENT AND ROUTER**

**ROUTER/SHAPER** (table-top)

**ROUTER BITS** (carbide-tipped, high-speed steel and spiral-grooved) Also, **PATTERN BITS** (using bearing or rub collars)

**SAW BLADES** (assorted)

**SCRATCH AWL**

**SCROLL SAW**

**SLIDING T-BEVEL**

**SQUARE** (carpenter's or combination)

**STEEL RULE** (assorted sizes)

**STRAIGHTEDGE**

**TAPE MEASURE** (dual-reading, steel)

**TEMPLATES** (used to cut inlay into installed floor)

**UTILITY KNIFE**

# DEFINITIONS

**Illustration A: Elements of a Hardwood Floor.**

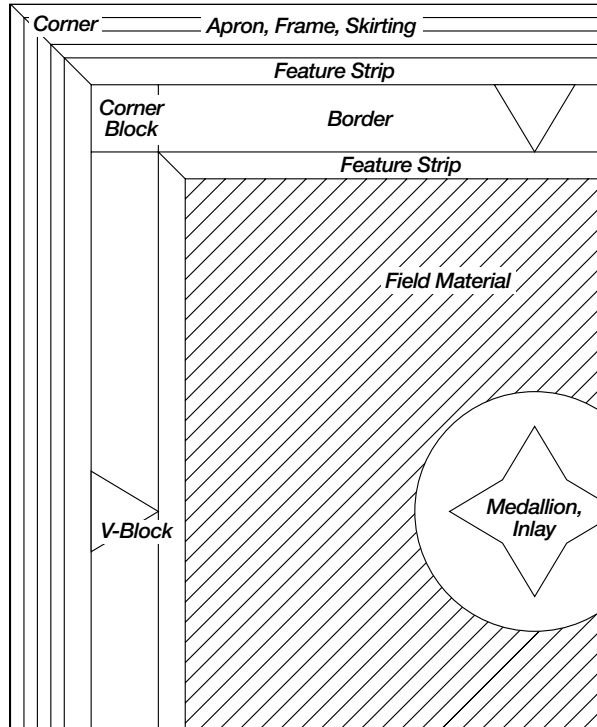

**APRON** - (See *Illustration A*) Wood flooring outside the border. Also called frame or skirting.

**BORDER** - (See *Illustration A*) Usually a pattern of flooring surrounding a room or at a transition area, outside the field.

**CNC-ROUTER-CUT** - A manufactured floor pattern created by use of a CNC (Computer Numerical Control) machining process and a router. (Compare with **LASER-CUT**.)

**CONTINUAL FLOW CORNER** - (See *Corner Types for Borders illustration, page 7.*) Also known as an integrated corner. A border designed so that the pattern continues through the corners, uninterrupted. (Compare with **CORNER BLOCK**.)

**CORNER BLOCK** - (See *Illustration A, and Corner Types for Borders illustration, page 7.*) A border element designed to complement the border pattern, interrupting the flow of the pattern at the corners. (Compare with **CONTINUAL FLOW CORNER**.)

**CUTTING ALLOWANCE** - When estimating the amount of flooring to be ordered, the extra amount needed to allow installers to make cuts as needed. This should not be referred to as "waste."

**DISTRESSED** - A texture in which the floor has been scraped, scratched or gouged to give it a time-worn, antique look. A common method of distressing is wire brushing.

**FEATURE STRIP OR ACCENT STRIP** - (See *Illustration A*) Usually a single board surrounding the room or at a transition area — often in another species and a contrasting color from the wood used in the field.

**FIELD** - (See *Illustration A*) The main area of the floor.

**FIGURE** - Inherent markings, designs or configurations on the surface of the wood produced by the annual growth rings, rays, knots and deviations from regular grain.

**FILLETS** - The small pieces used to form finger-block parquet patterns. Also called fingers or slats.

**FINGERS** - (See **FILLETS**.)

**FINGER-BLOCK PARQUETS** - Parquet pattern made from small strips of wood, typically quartersawn, bound together. (See **FILLETS**.)

**FLECKS** - The wide irregular, conspicuous figure in quartersawn oak flooring. (See **MEDULLARY RAYS**.)

**FRAME** - (See **APRON**.)

**HAND-CUT** - Non-production, specially cut pattern flooring. (Compare with **LASER-CUT** and **MANUFACTURED**.)

**HEARTWOOD** - The nonliving wood extending from the center of the tree to the sapwood. It is usually darker than sapwood. (See **SAPWOOD**.)

**LAPPED CORNER** - (See **LOG-CABIN CORNER**.)

**LASER-CUT** - A manufactured floor pattern created by use of a computer and a laser. (Compare with **HAND-CUT**.)

**LOG-CABIN CORNER** - (See *Corner Types for Apron illustration, page 7.*) A corner pattern in which the ends of perpendicular boards overlap, the end of one butting against the side of another. Also called a lapped corner. (Compare with **MITERED CORNER**.)

**MANUFACTURED** - A floor that is created by a manufacturing process and sold assembled to be installed on-site. (Compare with **HAND-CUT**.)

## Corner Types for Apron

### Corner Types with Parallel Apron

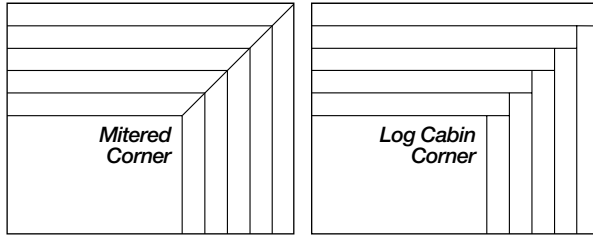

### Corner Types with Perpendicular Apron

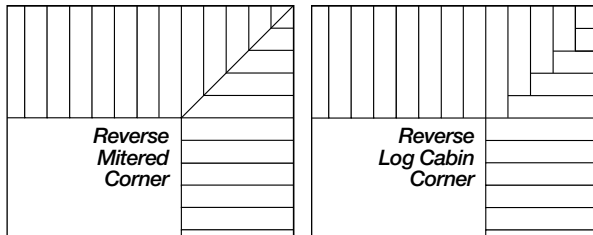

**MEDALLION/INLAY** - (See *Illustration A*) A pattern located at a focal point of the floor.

**MEDULLARY RAYS** - On quartersawn wood, the rays form a conspicuous figure, sometimes referred to as flecks or ray flecks. (See **FLECKS**.)

**MITERED CORNER** - (See *Corner Types for Apron illustration, above*.) Corner pattern in which two perpendicular boards are joined by cutting the ends of each at an angle. (Compare with **LOG-CABIN CORNER**.)

**MIXED MEDIA** - A wood floor that also incorporates other materials, such as slate, stone, ceramic, marble or metal.

**NOMINAL SIZE** - As applied to timber or lumber, the size by which it is known and sold in the market; often different from actual size.

**PARQUET** - A nonlinear, geometric, patterned floor.

**PATTERNED FLOOR** - A non-linear floor. (See *page 9 for examples of patterns*.)

**PLAINSAWN** - Lumber in which the annual growth rings make an angle of less than 45 degrees with the surface of the piece. This exposes the springwood and summerwood of the annual growth ring to produce a pronounced grain pattern. (See *page 11*.)

**PLUGS** - Square, round or butterfly inserts that are sometimes used to cover countersunk screws when installing plank, but may be used for purely decorative purposes.

## Corner Types for Borders

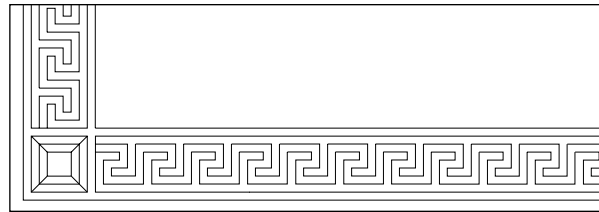

Greek Key border with a corner block.

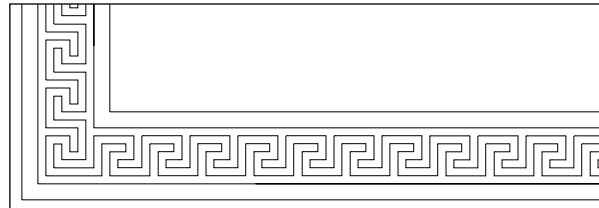

Greek Key border with a continuous corner.

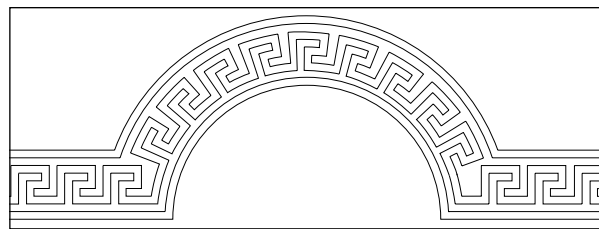

Greek Key border with a radius

**QUARTERSAWN** - Lumber in which the annual growth rings of wood form an angle of 45 to 90 degrees with the surface of the piece. In quartersawn boards, the medullary rays in ring-porous woods are exposed as flecks that produce a distinctive grain pattern. (See *page 11*.)

**RADIUS** - (See *Corner Types for Borders illustration, above*.) A border pattern designed to reflect a curved room element.

**RIFTSAWN** - Lumber in which the annual rings make angles of 30 to 60 degrees with the surface of the piece. Also known as bastard sawn. (See *page 11*.)

**SAPWOOD** - The living wood near the outside of a tree. It is usually lighter in color than heartwood.

**SKIRTING** - (See **APRON**.)

**SLATS** - (See **FILLETS**.)

**SLIP-TONGUE** - A spline or small strip of wood used to reverse or change direction in installing standard tongue-and-groove flooring, or when making and assembling parquet flooring.

**V-BLOCK** - (See *Illustration A*) A border element designed to allow adjustments of the pattern to fit at the corners.

# DESIGN CONSIDERATIONS

**C**ustom floors can be as simple as a basic feature strip done in a contrasting wood species. Or they can be as elaborate as an intricate floral design done in multiple species with hundreds of cuts. There are border and field patterns made by mixing media such as wood, stone and even metal. Ornamental borders can follow a room's perimeter or the hearth of a fireplace. They can mirror the shape of a chandelier in a foyer, surround a dining room table, or simply highlight the threshold of a room.

With so many designs and media available, choosing an ornamental border and field can be challenging. To make the selection process easier, determine the overall style of the interior — rustic, contemporary or traditional, for example. At this point, eliminate certain flooring design elements that typically do not lend themselves to that particular interior style. For instance, a Gothic ornament in a timber frame home with yellow pine floors might not work. However, a log-cabin corner or an inlay of pine cone designs might work well.

Next, consider the client's budget. Cost is varied as the intricacy and number of species used in the design. Sometimes designs can be selected based on their cost.

Make sure you and the client or clients are in agreement on how the chosen pattern will look when installed. Sometimes you will be dealing with multiple clients — the owner and the interior designer or architect. In any case, discuss with the client or clients what the focal points of the



room are and decide how the layout of the floor will take advantage of those focal points. Dry lay the pattern on the floor, and have the client or clients sign off on that layout before you begin installation.

## Fields and Borders

Custom fields and borders are an art form, and art tends to be subjective in nature. It is extremely important, therefore, to make sure all parties agree on the design of the floor. This is best done in drawings supported by written specifications. Drawings and specifications accomplish several things: They give the customer, designer, architect, general contractor and flooring contractor a good idea of how the finished product is going to look. Using drawings and specifications is the best way to ensure that the finished floor is what the customer expected.

Most custom mills will not quote on borders without a drawing, or at least a picture with written dimensions. It is probably best that the drawings and specifications appear in the blueprints so that their relationship to the overall structure of the room(s) can be appreciated.

The border's width is extremely important as it must suit the scale of the room or hallway. A 12-inch border would not be proportionate in a 4-foot-wide hallway, although that might be what the customer wants. The best place to work through the width requirements is in a drawing, and that is typically handled by an architect or the interior designer with the client.

The field pattern must also be complementary to the room. Most border designs work very well with plank or parquet. However, care must be taken not to border a relatively complex parquet pattern with a design that is equally or more complicated. The border defines the field, so it should contrast to some extent. A complicated border calls for a less intricate field, and vice versa.

A final consideration might be color. There are many wood species from which to choose. Add the different types of marble, and various metals that can be used, and the choices become endless. It is common to use the natural colors of the various media rather than relying on stain to impart color. If the existing color of the wood is used, the whole floor can be sanded at once and then finished with a clear finish. It is more complicated to stain the field with a dark stain and the border with a natural stain, and it also may create a dilemma the next time the floor is sanded.

From a design standpoint, a red-colored wood

such as Asian rosewood or mahogany can make a very nice accent to a room with a burgundy theme. On the other hand, a wenge and maple border can make a dramatic contrast with a predominantly light-colored room. Issues of color are best decided by the customer with help from an interior designer or architect. It must be noted here that some species are not compatible with others due to differences in expansion, bleeding of color and grain texture. Manufacturers and distributors can be invaluable in advising on the compatibility of wood species.

## Lighting

Incandescent, fluorescent, halogen and natural lighting have different effects on the appearance of a finished wood floor. Samples should be observed in the lighting environment in which they will be installed. You and your clients also should be aware that some species change color after prolonged exposure to light. *(For more detailed information on wood species, see Wood Species Used in Wood Flooring, NWFA Technical Publication No. A200. To order copies, contact NWFA at the address and phone numbers listed on the back page of this publication.)*

## Parquet Patterns

Many people think that large-scale parquet patterns are the most beautiful of all floors. Proper milling, installation and finishing of these larger patterns can yield stunning results, particularly in large rooms.

Parquet patterns — including many of those on this page — often take their names from famous people or places. The Monticello pattern, for example, is based on floors in Thomas Jefferson's home, and the Jeffersonian is a variation on that pattern. The Marie Antoinette pattern is believed to have been created under the auspices of the former French queen, and the Louvre pattern is based on the floors at the French National Museum of Art. Others, such as Brittany, Bordeaux, Canterbury, Fontainebleu and Saxony are named for places where they are thought to have originated.

Then there are the geometric patterns with more generic names, like herringbone, rhombs and standard pattern parquet, which is sometimes called fingerblock parquet. Fingerblock parquet, however, is any parquet pattern made up of small strips of wood (called fingers or fillets) assembled together.

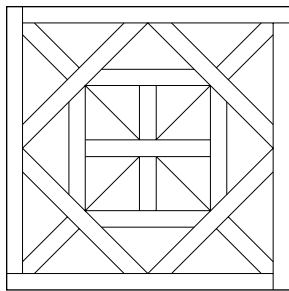

Bordeaux

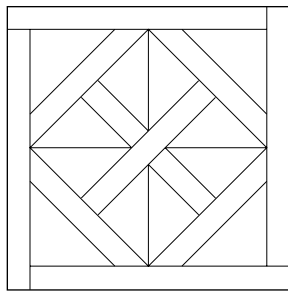

Brittany

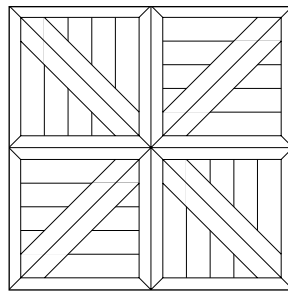

Canterbury

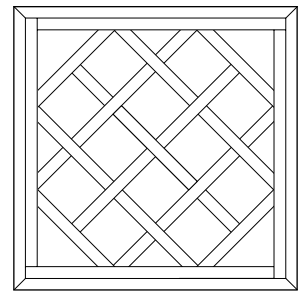

Fontainebleu

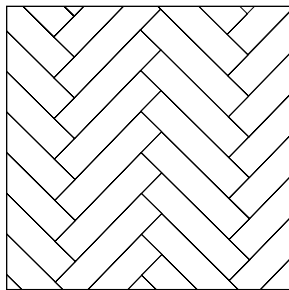

Herringbone

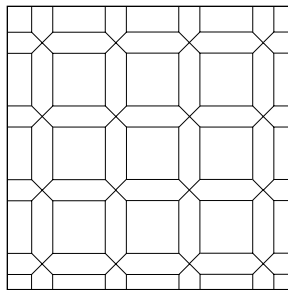

Jeffersonian

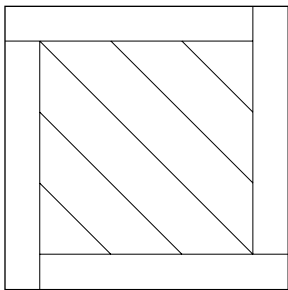

Louvre

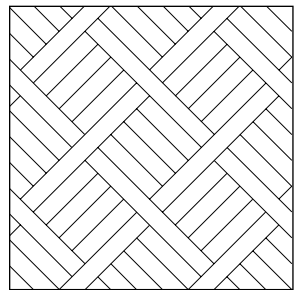

Marie Antoinette

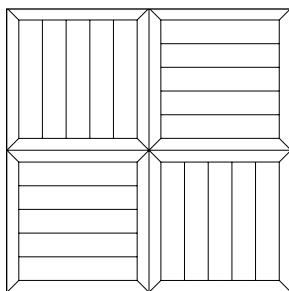

Monticello

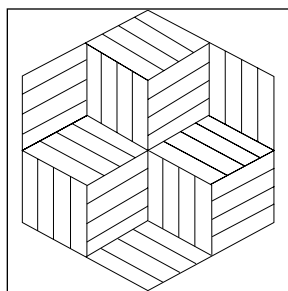

Rhomb

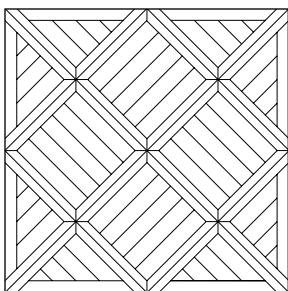

Saxony

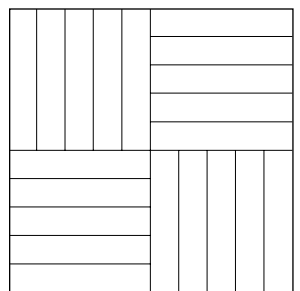

Standard Pattern

# SELECTING MATERIALS

## Wood Species and Milling

Just as you consulted with your client on floor layout and pattern, certainly you will want to discuss the wood species to be used, as well as the cut of wood — plainsawn, quartersawn and riftsawn.

*(Note: For more detailed information on wood species, see Wood Species Used in Wood Flooring, NWFA Technical Publication No. A200. To order copies, contact NWFA at the address and phone numbers listed on the back page of this publication.)*

Different species of wood have different rates of expansion and contraction. As a rule, the larger the piece of wood, especially in width across the grain, the more potential there is for movement-related problems. The best way to minimize movement is to use parquet patterns. Patterns will usually run in at least two different directions, which will greatly lessen movement of the floor. That's because the wood is expanding and contracting in two or more directions, reducing the effect in any one direction.

Different species of wood can vary greatly in hardness and other characteristics. That can present a challenge if a contractor chooses different species to attain the customer's desired color combinations, and one species is significantly harder than another. The two woods will wear differently, with the softer wood showing high-heel marks and other wear more than the harder wood. Different species of wood also respond to sanding and finishing differently. It is imperative that the customer be made aware — preferably in writing — of the effects of using woods of different species.

American hardwoods such as red oak, white oak, walnut, cherry, ash, pecan and maple are readily available. Some imported woods (santos mahogany, wenge and purpleheart, for example) may require more lead time in the ordering process.

Customers have a variety of options in flooring, including species, grade, cut and length of boards. For example, a customer could specify "selected for sapwood" maple, No. 1 Common red oak, or all quartersawn (no rift or plainsawn) ash. Sometimes the customer's specification requires a custom order. If there is production time involved for a custom specification, considerable lead time may be required. Contact a local distributor, mill or the NWFA for sources of custom milled floors.

The National Oak Flooring Manufacturers Association and the Maple Flooring Manufacturers Association publish grading standards for many species. NOFMA has four grades for unfinished oak — clear, select, No. 1 Common and No. 2 Common — and three grades for prefinished oak — prime, standard and tavern. There are three grades for maple — 1st,

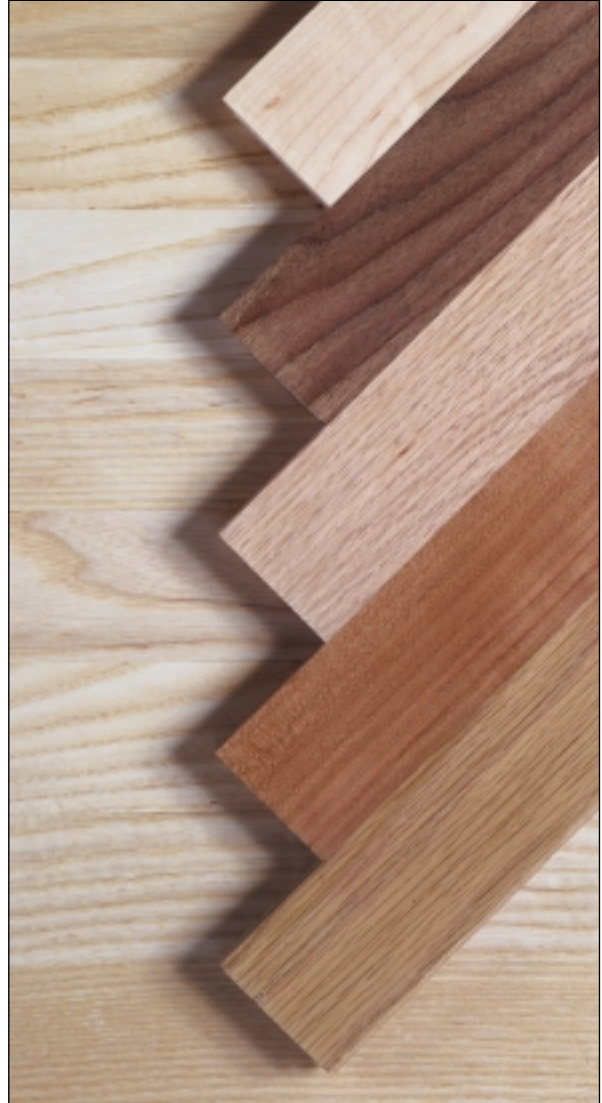

*Top to bottom: Maple, walnut, red oak, cherry and white oak are just a few of the choices available.*

2nd and 3rd — used by NOFMA and MFMA. There are grades for most other species, as well, and many manufacturers of flooring also have proprietary grade names.

You should be aware of how different grades of wood flooring are defined so you can explain the differences to your customers.

The length of flooring is specified by grading rules. However, some mills also produce longer length by custom order. A custom specification might read, "¾-inch-by-3-inch, quartersawn, heavy flake, 4 foot and longer, white oak."

There are many other custom features available in custom flooring. Hand-scraped, beveled and



hand-distressed flooring is available. These materials are not without their cost, but there are floors in the United States that have been installed in the last five years that duplicate the look of hardwood floors in some of the parliamentary halls and castles of Europe.

Note: Not all manufacturers of wood flooring use the same tongue-and-groove profile or placement. If a contractor is using wood from different mills, he or she should be certain that the wood will fit together properly, or be prepared to re-cut grooves and use a slip-tongue or spline.

## Mixed Media Custom Floors

Some of the ornamental floors with the greatest impact are those that use combinations of wood, metal and stone. The use of complementary and contrasting media is a centuries-old method of creating rich color and texture variation in ornamental flooring. While working with the varying characteristics of these materials can be challenging, the finished product is worth the extra effort. Custom flooring manufacturers and distributors can be an invaluable source of education for the availability and compatibility of various media.

### Stone

Stone (natural or manmade) can be used as a border, accenting the field and other materials used within the project. A granite inlay can be used to accentuate a granite countertop in a kitchen. A marble border can be used in a wood floor to complement an adjoining marble floor. Using wood and stone in foyers, living rooms and dining rooms can tie different spaces together so that the rooms flow from one to another.

The use of marble or granite with wood in a custom pattern can be dramatic. For example, a ¾-inch-by-12-inch-by-12-inch "Monticello" pattern with 8-inch, solid wood centers with two-inch pickets is transformed with the replacement of the 8-inch wood centers by Verde (green) marble.

### Metals

Brass, copper, stainless steel, nickel and other metals are used to highlight other media, as their simple but striking brilliance tends to be very distinct. Used in moderation, metal can tie together like species within a pattern, or else accentuate different species within a pattern or border.

*(For more on mixed media, see "Mixed Media: Installing Metal and Stone," page 18.)*

## Ordering Materials

See "Takeoffs (Material Requirements)," page 12.

Given the high cost of materials for some custom floors, it is important to minimize cutting allowance by limiting unnecessary cuts. This can be done by

knowing the specifications of the material and proper layout. Depending on the supplier, you can order material by board feet, square feet or lineal feet, but be sure you know which one you're using. Mistakes can be made if you think you're ordering square feet and you get board feet.

When estimating marble, granite and slate, contractors should note that the size stated is usually nominal and the actual size is smaller. For example, a 12-by-12-inch piece of marble is not necessarily 12 inches square.

The thickness of the material must also be considered. Many patterns are manufactured using ¾-inch hardwood flooring and ⅝-inch stone. The stone must be leveled with subfloor or cement-based material so it is flush with the height of the hardwood.

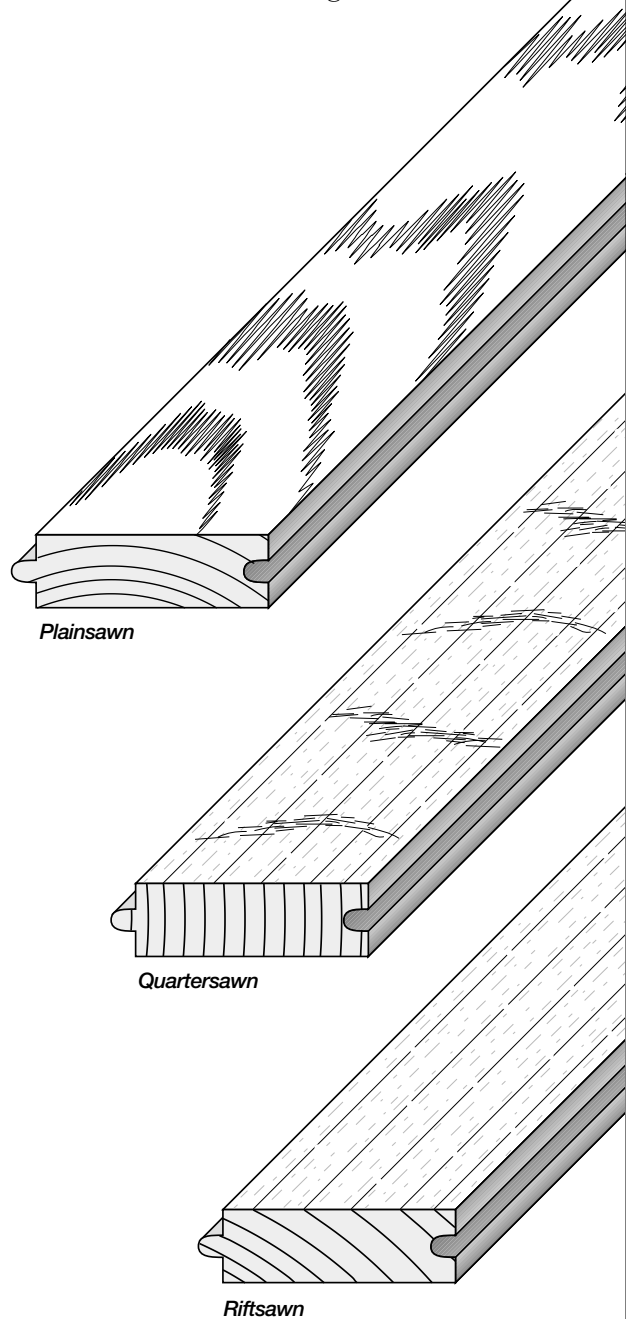

# INSTALLATION

## Ornamental Borders and Fields

The basic components of a custom wood floor installation are the field, the border and the apron, also called the frame or skirting. (See "Definitions," pages 6-7.) The field is the main area, or center, of the floor, and the border typically surrounds the field. In many cases, the apron surrounds the border and runs to the wall. There are many variations on this composition. A different floor pattern, for example, could be used in a doorway to set off one room from another. This would be termed a transition area. A foyer might have a 48-inch, round medallion surrounded by 3-inch plank flooring (the field) that runs to the walls.

This text will proceed through methods of design, installation and finishing an entire custom floor of the field, the border and the apron.

## Takeoffs (Material Requirements)

When calculating the amount of border materials required, the first consideration is its placement in the room. As you can see in Diagrams 1 and 2, both rooms are the same size, but the different placements of the border call for different lineal footages of border materials.

After determining the lineal footage of border required, consider the number of corners, or angle blocks, needed. Corners and V-blocks allow for changing direction in a smooth and attractive manner. A design selection or a physical condition, such as a wall, may dictate that the border follow a curve.

Borders require a cutting allowance that is defined by the approach to the corner block, or to the center of a run. The general rule is to calculate linear footage including the corner blocks, unless the corner blocks are very small.

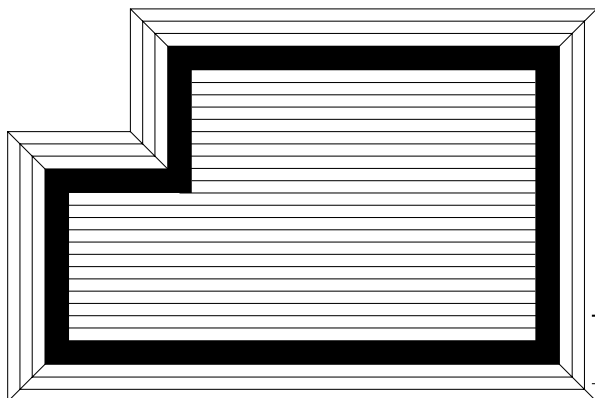

Diagram 1

The calculation of the field and apron is fairly straightforward. Keep in mind, however, that with patterns, the field dimensions should work out so that the outside edges of the field and apron finish with half or whole repetitions of the pattern. Finishing with partial pieces would not be pleasing to the eye.

(Note: The width of the apron on one or more sides may be adjusted to allow for a full repeat.)

## Basic Layout

Most border installations are typically placed about 12 inches from the walls. This is done so that the border is not hidden from view, and so that adjustments can be made to provide equal-width aprons for ends and sides. Cuts are made along the outer perimeter. The apron can be laid either parallel or perpendicular to the border and can be either lapped or mitered at the corners.

Assume the border is to be laid 12 inches from the wall, that it measures  $\frac{3}{16}$ -inch thick and 11 inches wide, including the two outside feature strips. Working from the center out, the goal is to lay the field ending with a full strip meeting the border on two sides.

Note: With a parquet installation, end with equal cuts on four sides if possible. Measure from the inside edges of parallel border sides in multiples of the width of the field flooring product. Adjust where the border will go on both sides to allow for a full strip of flooring to be installed.

If opposing walls are not parallel, care must be given to place the field where it allows for equal halves of the distortion on each pair of sides; in other words, so that the field is truly centered. Snap chalk lines where the field ends and the border begins.

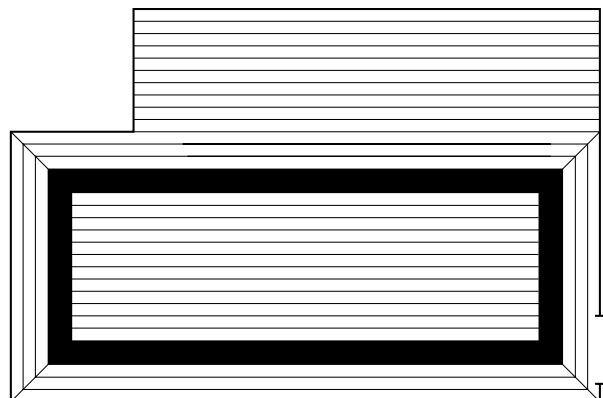

Diagram 2

## The Border

Before installing the floor, dry lay the entire border and flooring around the room. Note how the border will approach the corner blocks. Be sure that the approach to the corner blocks flows smoothly and is aesthetically pleasing. Most borders are designed to be cut directly at the corner block no matter where the pattern falls. Some borders, however, have more custom “continual flow” (or integrated) corner blocks that allow the border to continue through the corner with no interruption in pattern. (See “Definitions,” pages 6-7, for examples of different types of corners.)

Using continual flow (or integrated) corners will require the adjustment of the pattern in the middle of the sides of the border with a V-block to allow the corner to accept the end of a repeated section properly.

Some border patterns may require “right-hand” and “left-hand” sections in order to flow properly.

After determination of how the border will be laid, and how it approaches and meets the corner blocks, install the field before making any cuts on the border materials.

## Measure, Measure, Measure

Before beginning to install the floor, make sure all measurements are accurate. In particular, measure the space needed for the border and dry lay the border before installing the field. However, a dry layout should never be used for precise measurement purposes.

Once you’ve begun installing, continue to take measurements, then adjust your installation as needed.

## Laying Out Working Lines

### Parallel layout:

For parallel layouts, you will need to begin with 90-degree working lines at the center of the room.

#### To establish a 90-degree working line (See Diagram 3A):

Start by snapping a chalk line through the center of the room (line Y). The next line (X) must be exactly 90 degrees to line Y to form a perfect square corner. To ensure this angle, do the following:

1. From the center point (A) of line Y, measure 4 feet along line Y and mark that point (B).
2. From the same center point, measure 3 feet in the general direction of where line X will be and scribe an arc.
3. Return to the original 4-foot mark on line Y and measure 5 feet, scribing an arc that crosses (point C) the 3-foot arc you made in the previous step.
4. Verify all measurements before proceeding.
5. If correct, snap a chalk line through the conjunction of the two arcs and the center point of line Y. This will be line X, at an exact 90-degree angle to line Y.

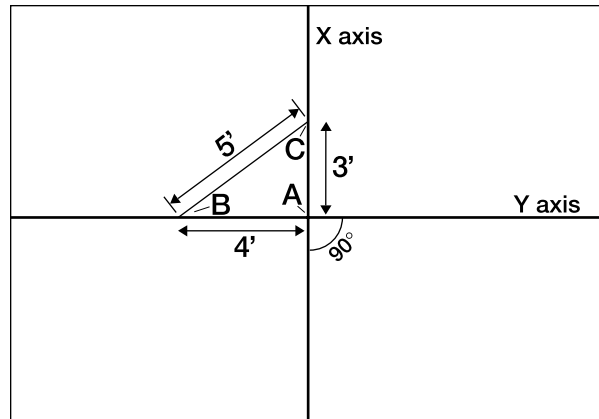

Diagram 3A

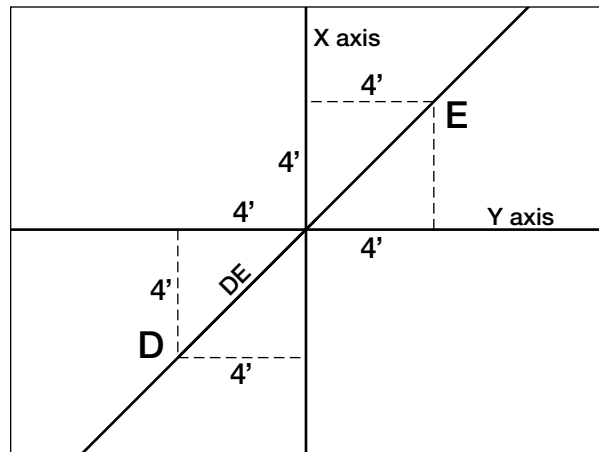

Diagram 3B

### Diagonal layout (standard):

For diagonal layout of linear or uniform-size units, you will start with a diagonal working line in the center of the room. (Herringbone installation requires a different working line. See Diagrams 3D and 3E on page 14.)

#### To establish a 45-degree working line (See Diagram 3B):

Line DE must be at exactly a 45-degree angle to lines X and Y to form working lines for diagonal layout. To ensure this angle, do the following:

1. From the center point, measure 4 feet down in each direction on lines X and Y.
2. From each of these points, measure 4 feet and scribe an arc. The conjunction of these arcs creates points D and E.
3. Snap a chalk line between points D and E, and the center point. This line represents a 45-degree angle.

### Parallel and diagonal layout:

For either parallel or diagonal layouts, you need to establish working lines at the perimeter of the room. In Diagram 3C, dotted lines A and B will represent the estimated inside working lines of the border.

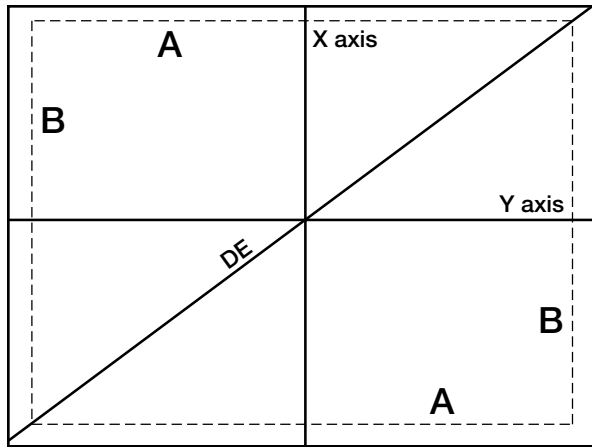

Diagram 3C

**To establish perimeter working lines (See Diagram 3C):**

The distance between the two parallel lines A should be equal to a multiple of the width of the materials being installed. Parallel lines A should also be equidistant from their adjacent walls. These lines should be adjusted to fit the width and the aesthetics of the border design. If the number of pattern repeats is uneven, it will be necessary to adjust the Y axis working line so that the pattern is even on each side of the room. Using a chalk line, snap parallel lines A, which represent the inside of the parallel border.

To establish perpendicular lines B, parallel to each other, measure the distance between one parallel line A and the adjacent wall. That dimension represents the reference distance between perpendicular lines B and their adjacent walls. Measure the distance from the reference point of line B to the X axis line. Perpendicular lines B must be equidistant from the X axis line. Once these lines have been established, snap working chalk lines. These lines represent the inside of the perpendicular border.

For fields installed on a diagonal, it is important to adjust lines A and B to represent a distance from the wall that is equal to a multiple of the width of the units installed as the border. Snap a chalk line at this point; that line now becomes a working line.

**Herringbone layout:**

For a herringbone pattern to appear centered and repeat equally at the walls, an additional working line needs to be established, parallel to line Y or X, depending on the direction in which the pattern is to be installed. Herringbone direction should be installed in accordance with consumer preference. The direction may look best when installed with the points in the direction of the longest dimension of the room, or directed toward a major focal point. If the pattern is to be installed in the direction of the length of the room, the herringbone working line should be laid out parallel to line Y.

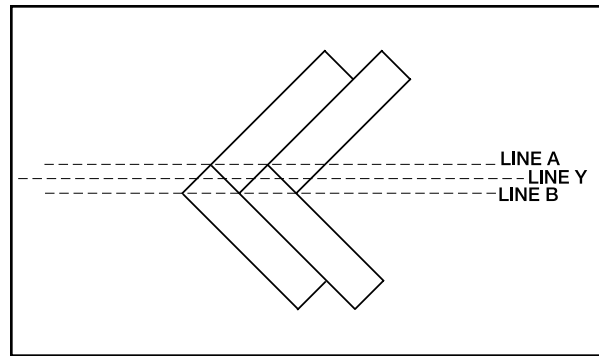

Diagram 4A

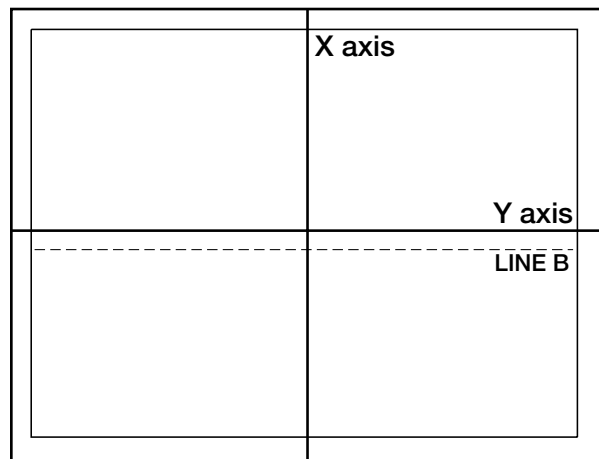

Diagram 4B

**To establish a herringbone working line (See Diagrams 4A and 4B):**

Line B in this instance must run parallel to line Y and represent the center of the herringbone material. To determine the center of the herringbone material and establish line B:

1. Begin by laying out a few alternating slats. (See Diagram 4A.)
2. Snap line A and line B through the corners of the alternating slats.
3. Measure the distance from line A to line B. The working line should be one-half that distance and run parallel to line Y. (See Diagrams 4A and 4B.)

**Methods of Installing**

**Before starting installation**

There are several possible methods of installing a field in conjunction with the border. Each has advantages and disadvantages. Most patterns will likely require cutting some boards and pieces, and/or using spacers to make the strip, plank or parquet fit the space. Some installers prefer to install the apron and the border first, then install the field within. However, it may be easier to install the field first, working from the center of the room outward. Space must be left on the outside of the field for the border and apron, which are usually installed last. Layout and installation alternatives

should be discussed prior to beginning the project. Particular attention should be paid to such things as fireplaces, door openings, designed vaulted ceilings or other visual focal points.

Carefully measure the room to see if opposite walls are parallel and if the corners are square. Don't be surprised if adjustments are required. It is usually best to make adjustments where the border or apron meets the wall. The field must be straight and square. The opposite sides must be parallel to and equidistant from the borders. Installing a parquet in this manner will ensure equal cuts on both sides, and the repeated pattern creates a convenient reference for checking the border against the alignment of the field.

### Installing the border first

Some manufacturers may recommend installing the border first. In these cases, follow the manufacturer's recommendations for installation techniques.

### Installing the field first

**Parallel or diagonal (standard):** In the case of parallel layout, installation of the flooring will be done from the center of the room outward, beginning at the parallel working line. In the case of diagonal layout, installation of the flooring will be done from the center of the room outward, beginning at the diagonal working line.

To accomplish this, install the first three or four rows against a straightedge.

For tongue-and groove flooring only: After the first rows have been installed, remove the straightedge and glue a spline/slip-tongue (see diagram 6, page 16) in the exposed groove of the first row. Properly attach the spline with glue only in glue-down applications, and with glue plus cleats or staples, 8 to 10 inches apart, when the floor is mechanically fastened. The spline is used to reverse the direction of tongue-and-groove flooring units.

In glue-down applications, adhesive should not be spread past the border working line. As the flooring is being installed, allow the ends of each row of flooring to extend past the border line on perpendicular lines B. Do not place fasteners within 1/2 inch of this working line when installing mechanically fastened systems. This is to prevent damage to power tools when completing the following step.

After the field is installed, use a straightedge as a guide to cut the ends of the field flooring along the border line. Three-quarter-inch-thick materials and some species of wood require multiple cuts or passes to prevent the blade or bit from drifting off of the straight edge. When installing prefinished product, the surface should be protected from potential scratches along the border/straightedge line. This can often be accomplished by the application of a protective surface on the face of the base plate of the power tool. Cutting of prefinished products may require the use of quick-release tape along the cutting line to protect the surface, prevent chipping and to eliminate edge burring.

Prior to installing the border, when possible, cut a

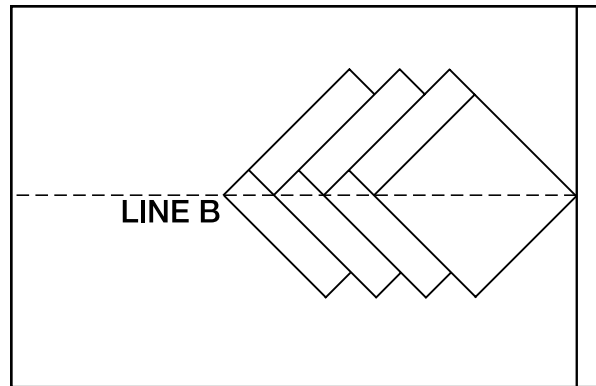

Diagram 4C

groove for a slip-tongue or spline where necessary. This may be accomplished with the use of a router and bit designed for that purpose and for the thickness of flooring.

**Herringbone installation:** To begin installation on line B (see Diagram 4C), cut a square piece of plywood the size of the herringbone pattern you are installing. (For example, if the herringbone is 3 inches by 12 inches, cut a 12-by-12-inch piece of plywood.) Nail this piece of plywood at your starting point on line B, with one corner of the square pointing in the direction of your layout.

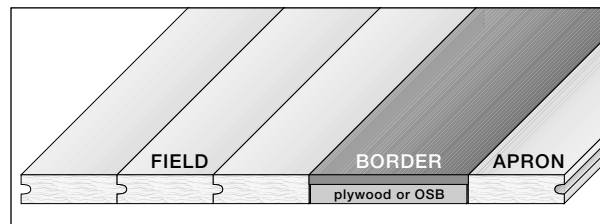

Diagram 5

### Building up the subfloor

When using flooring of different thicknesses for the field and border, the subfloor must be built up underneath the thinner material, using plywood, OSB (Oriented Strand Board) or other approved subfloor materials. (See Diagram 5.)

Using construction adhesive and screws, glue and screw the subfloor material to the floor. Remember, the flooring needs expansion space. Do not butt the subfloor material tightly against the adjoining material.

### Installing the border

Spread a good quality wood flooring adhesive (follow the recommendations of the wood flooring manufacturer) onto the subfloor material. Be sure to use the trowel size and trowel profile recommended by the adhesive manufacturer and to also heed the adhesive's flash-time and open-time directions. Lay the inside feature strip along the edge where it meets the field.

Note: It may be necessary to use small brads in some areas to hold the strip down initially. Be sure to countersink the brads.

Next, starting with the corner blocks, lay the border, followed by the outside feature strips. Peel the tape off the face of the border, and adjust any pieces that are not properly aligned. Some gaps are to be expected. These gaps can be filled later, but only after the adhesive is allowed to dry. That allows for further expansion or contraction caused by the curing adhesive.

### Tongue-and-groove borders

Tongue-and-groove borders can be blind-nailed along with the field. Where the border runs parallel to the field, the border can be blind-nailed in the same direction as the field. Where the border runs perpendicular to the field, you will need to rout a groove in the ends of the field boards, then insert a slip-tongue. The groove side of the border can then be installed against the slip-tongue and the border can be blind-nailed.

Lay the field so the ends of each row extend an inch or two beyond the border working lines, but do not nail within  $\frac{3}{4}$ -inch of these lines.

After the field is laid, use a straightedge and a circular saw to cut along the snapped lines. Rout a groove along the entire length of the cut edges and insert a slip-tongue — also called a spline. (See *Diagram 6*.)

Install the corner blocks and border as described above in “Installing the border.” To install the apron, start with the grooved ends of the strip flooring and interlock them with the tongue sides of the border.

### Installing borders with parquet fields

With a parquet installation, use the same techniques as in the initial instruction. The width of the apron can be adjusted to help create an aesthetically pleasing appearance on each side of the room.

### Installing the apron

Install the apron according to the layout. If the apron is installed parallel to the border, the first board must be face-nailed to avoid the shock of nailing the starting board against the border. If the apron is installed perpendicular to the border, the first board will need to be face-nailed to ensure a square joint between the apron and the border. If the corners of the apron are mitered, it is best to rout grooves and spline them together for stability. A router table will come in handy for mitering the corners.

### Inserting a slip-tongue or spline

Slip-tongues (also called splines) can be used for various purposes. As shown in *Diagram 6*, a slip tongue can be used to reverse the direction of flooring — a technique that might be used, for example, when installing the field outward from the center of the room. The slip-tongue should be fastened in place by nailing every 8 to 10 inches

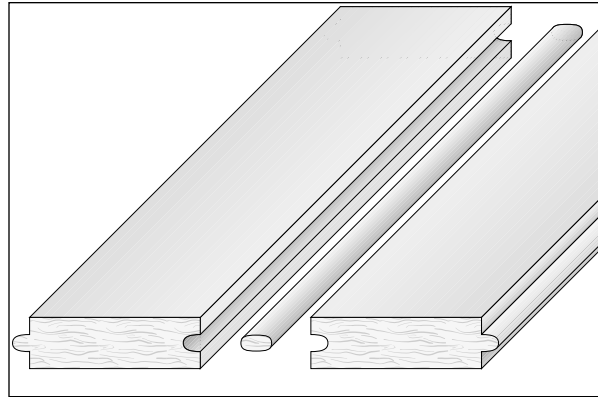

*Diagram 6 — Slip-tongue/spline insertion*

through the slip-tongue. (Some installers also glue the slip-tongue in place with carpenter’s glue.) A slip-tongue might also be used to link a border to the field. (See “Tongue-and-groove borders,” left.)

### Preparing the floor for sanding

Before sanding the floor (see “Sanding and Finishing,” page 20), allow the adhesive to cure according to the manufacturer’s directions. When filling the floor prior to finishing, try to use color-matched fillers wherever possible. Ask your distributor for recommendations of appropriate fillers.

### Notes and Tips

- Lay out the border prior to permanent installation. The importance of this cannot be stressed enough. It is particularly important to ensure proper approach and butting to the corners.
- In parquet installations, the apron area will generally be composed of feature strip. In this case, remember to calculate the amount of feature strip, or skirting, needed as part of your material needs when ordering.
- Most premanufactured borders are installed tape or paper-faced up, although some are mesh-backed. Follow the manufacturer’s directions carefully.
- Most borders repeat the interior pattern design at particular intervals. This is important when departing from a continuous corner block. In order to maintain continuity, calculate the linear runs of the border in appropriate intervals.
- When installing slats in adhesive in a mixed-media installation, lay out and snap lines for both sides of the slats for the entire job. If you spread the adhesive within those lines, you eliminate the scraping of adhesive from areas of the subfloor that might require other types of adhesives (stone or tile, for example).
- Whenever possible, have the client sign off on all choices made before and throughout the process.

## Installing Inlays and Medallions

### Premanufactured inlays and medallions

There are two basic types of inlays and medallions — premanufactured and jobsite-manufactured. Within the premanufactured products, there are also two types — laser-cut and machine-cut — including CNC-router-cut. Some customers can tell the difference, so be sure to show your customer samples of what you're planning to install and have them sign off on that choice before you begin installation.

### Applications

There are numerous applications for inlays, ranging from the most subtle to the very ornate. Borders, medallions, fireplace wraps, risers for stairs, thresholds, accent pieces, mantle or soffit facings can all match the floor design. Also, corporate logos are frequently used in commercial work.

### Some installation procedure tips

- When using premanufactured inlays and medallions, check your order immediately to ensure there are no missing parts or damage in shipping. If a shop drawing was required, compare the drawing to your new inlay for accuracy in measurements and selection of species.
- Acclimate your inlay to the jobsite (if it is secure), and allow a minimum of 96 hours in a "conditioned" environment before its installation. The HVAC system needs to be working on your project with temperature and humidity that is acceptable to normal living conditions.
- Use the basic hardwood floor installation guidelines to check for moisture in the air and on the subfloor, to ensure everything is ready.
- Lay out your inlay by taking into consideration the walls, vents, openings and, if possible, the furniture that will surround the proposed project. Dry lay your inlay first to check for proper fitting, as this process will allow for adjustments before gluing. This is an opportune time for your customer to approve the layout and sign off on this stage of the installation.
- Determine the thickness of the floor in which the inlay is being installed, and ensure the inlay will match the elevation. Most laser-cut inlays are  $\frac{5}{16}$ -inch thick, requiring a substrate to be glued to the bottom to match the floor. For example, with a  $\frac{3}{4}$ -inch floor, you would need to glue a  $\frac{1}{2}$ -inch subfloor material to the bottom of the inlay, thereby achieving the same elevation as the floor. Most companies offer their inlays glued up as an option to eliminate the liability exposure. Plus, it saves installation time.



*Many companies provide templates with their medallions as a guide to routing the area needed.*

- Medallions should always be installed after the floor is installed to ensure tight fitting into the floor. A router can be used to cut out the area needed for the medallion.

Medallions can be installed by placing the actual medallion over the proposed area to be installed, and marking the floor all the way around with a pencil.

Most companies offer a template, thereby reducing the chance of making bad cuts outside the proposed area for the inlay. With a factory template, after routing, chisel out the inside portion of the wood and clean out thoroughly. Lay out the medallion into the new opening and check for proper fit.

- Glue the inlay by applying a liberal amount of adhesive to the bottom of the inlay and directly to the substrate (interior-grade subfloor material) in a thickness that will match the overall elevation of your floor. Follow the inlay manufacturer's recommendations on proper adhesives to use. Follow the adhesive manufacturer's recommendation for ventilation, application and drying time.
- Check for knockouts — free, loose pieces — and secure them to the subfloor. The medallion should be screwed to the subfloor. The knockouts should be glued into place in the medallion.
- Most inlays require filling the gaps where the various parts connect. Fill the inlay with a wood filler that will match the color of the wood species used within your inlay. There are numerous color-compatible commercial wood fillers.
- Sand the inlay with the floor up to 120 grit or higher if possible, and use the same procedures as you would on other hardwood floors. If you are using a drum or belt sander, keep the sanding surface as flat as possible going over the inlay.
- Finish the inlay in the same fashion that you would any hardwood floor, using any finish compatible with the wood species. (Some species of wood are not compatible with certain finishes. Refer to finish manufacturers' recommendations.) Many installers use a clear finish without stain to preserve the natural beauty of the species.

## Mixed Media: Installing Metal and Stone

One place where a mixed message can be widely appreciated, even encouraged, is the hardwood floor. Marble, granite, brass or stainless steel can add to the lustre of a premium hardwood floor design, or give elegance to a standard strip pattern.

Learning an entirely new trade isn't really necessary for the simpler applications, and the more difficult ones can be navigated using the same commonsense approach used when working with wood.

However, brass and stone do have certain properties that make them a little more complicated. Stone requires specific types of epoxies and special care in sanding. Some varieties are more difficult to cut than others. Brass is a soft alloy and can be polished, sanded or brushed.

You do need certain specialized skills to work with mixed media, and that added to the higher cost of brass and stone limits its appeal with many contractors. But the visual effect of even the smallest touch of brass or stone can make the extra work worthwhile.

*(See "Sanding and Finishing," page 20, for more details on sanding and finishing mixed media.)*

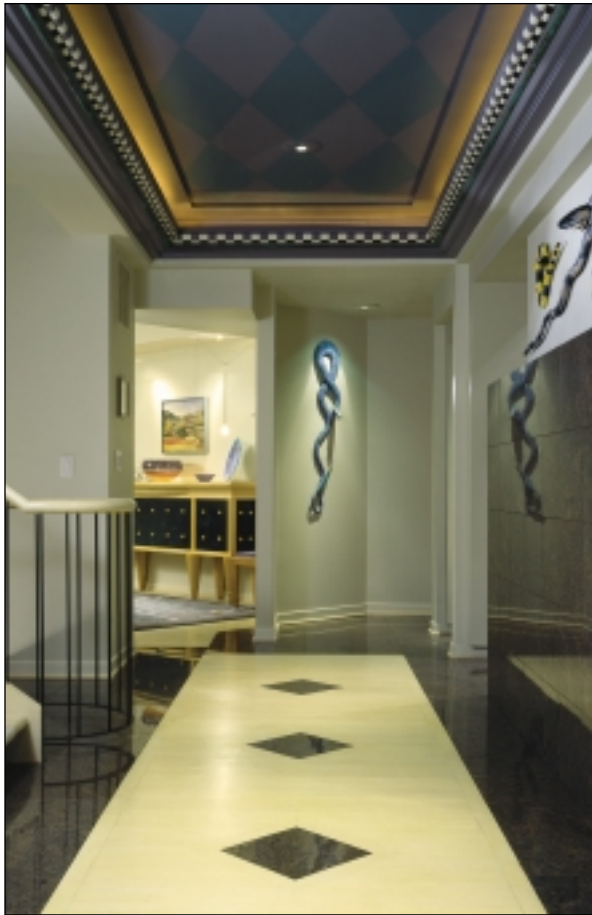

## Brass

Because of its pliability, brass can be utilized in a variety of ways. It can be bent and soldered into intricate forms that are routed into a floor all in one piece. It can be built into a parquet pattern off-site and then laid as a prefinished floor. Or it can be installed on-site and set in place as a border.

Brass can be polished, scraped, sanded and even dulled with lye to achieve an old-fashioned patina.

Yet, as a substance sharply removed from wood, it can react in unexpected ways to the most basic tools of a flooring contractor's trade.

For example, brass heated by swirling sandpaper will expand, and might then break loose from its epoxy, curl up from its slot and just refuse to sit back down again. It may even transmit its heat to the wood, singeing it.

Some installers use nails and a strong epoxy to avoid having a metal inlay curl up. In borders, the brass strip will be top-nailed or blind-nailed into holes predrilled into the brass.

Great care has to be exercised in sanding, both to lessen the possibility of overheating and to guard against swirl marks left by the sander.

In spite of these difficulties, the soft, changeable quality of brass makes it one of the easiest metals to work with.

Brushing with steel wool gives brass a shiny but muted appearance.

## Installing brass, copper and aluminum

It's preferable to use ¼-inch thick metal, in whatever width you desire. To install these metals, you will need a plunge router and a high-speed, steel router bit, the same width as the metal strip you are installing. You will also need an adhesive — preferably a two-part epoxy with a long mixing tip. And, you'll need solid brass, copper or aluminum nails, depending on which metal you are installing.

Figure out the amount of metal you will need and precut it for installation. You must predrill the metal at 9- to 10-inch intervals along the entire length of the metal strips. The drill bit should be the same diameter as the nails you are using.

Clean the brass, using sandpaper or lacquer thinner — but do it away from the floor — so that adhesive will bond well to the metal and the wood floor.

At this time you're ready to install the metal, but some manufacturers recommend that you sand and screen the floor and apply a sealer coat first.

Snap chalk lines to show where the metal is to be installed. Use a straightedge tacked to the floor

*Wood flooring and stone together can produce an elegant appearance.*





*Left, brass and ebony combine in this simple border, surrounding a red oak field.*

*Below, brass is inset in this ebony and padauk border, set in an oak strip and parquet field.*

to help guide your plunge router and bit. Depending on the depth of the metal you're using, it may take three plunges or more to cut down to the depth required for the metal inlay. If, however, you are using  $\frac{1}{4}$ -by- $\frac{1}{4}$ -inch metal, a single cut with a  $\frac{1}{4}$ -inch router bit will give you a perfect fit. Also, plunging down only  $\frac{1}{4}$  inch reduces the chances of hitting flooring nails, which can damage your bits.

Apply adhesive into the channel you have cut. Do a section at a time, since most epoxies have only a five-minute working time. Place the metal into the channel and install nails into the predrilled holes. Using both epoxy and nails gives a more secure fit, reducing the chances that the metal will pop out of the floor when you sand it. After all the metal is installed, sand off the nail heads flush with the surface. Then apply finish.

### Stone

Different types of stone also vary in hardness, but most contractors agree that working with stone doesn't take the same degree of expertise as working with brass and other metals. Once it's cut, stone can be treated like just another piece of a larger puzzle.

Most stone can be sanded without major problems, except for granite, which also takes a little more time to lay properly. Because granite doesn't withstand sanding well, some installers leave the factory finish on and don't lay the stone until the rest of the floor is completely sanded and finished. Plywood blanks screwed into the floor where the stone will go solve the problem of finishing an unfinished floor.

Some clients prefer to have the stone inlays sanded at the same time as the floor, because the sanding process removes the sheen of the stone surface and leaves a more natural, aged patina.



### Caution

Since wood, metal and stone are such different materials, it's inevitable that each will react differently to environmental conditions. Also, because of the likelihood of those changes, installers may need to leave expansion gaps near metal and stone inlays, just as they do around the perimeter of the room. And, since environmental conditions and underlayments vary widely, installers need to be aware that different adhesives may work better in some installations and in some parts of the country than others. Epoxy tends to be a good choice, but it is far from foolproof.

The bottom line is that installing metal or stone may be more difficult than it might seem at first, and it never pays to cut corners.

The wise installer takes nothing for granted and carefully considers the potential pitfalls of working with such different materials. Planning ahead to avoid those pitfalls will increase the likelihood that the finished floor is as attractive as it was first envisioned by the installer and the owner.

# SANDING AND FINISHING

**S**anding and finishing ornamental wood floors requires the consideration of several additional factors that do not apply to the finishing of strip or plank flooring. Custom floors tend to have intricate patterns and different species of wood, stone and even metal. Some considerations are:

- Frequently, the wood grain does not run in the same direction.
- The use of different media (wood, stone and metal, for example) will place materials of greatly varying hardness and density next to each other.
- Different species and non-wood materials may react differently to sanding, stains and finishes.
- Different sanding procedures and additional labor will be required when sanding and finishing ornamental floors.
- Special sanding techniques are required when sanding floors that include multiple species of wood and those that include mixed media.

## Sanding

### Varying grain direction, hardness and density

Where wood grain does not run in the same direction, different sanding procedures must be employed to ensure that the action of the abrasive does not make the surface uneven.

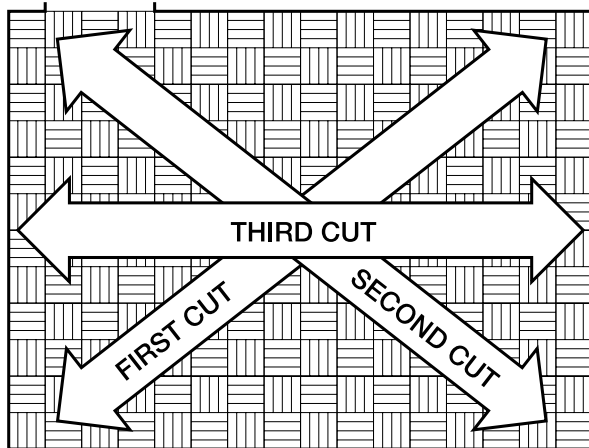

Diagram 7

*When sanding a surface where grain patterns differ (a parquet pattern, border or inlay, for example), cut at a 45-degree angle to the floor in two directions. You must also make a third cut along the room's longest dimension, and you may also make a fourth pass, using a floor polisher and hard plate. Remember to use a progressively finer grit for each cut. Extra hand-sanding work may also be required.*

A large drum or belt sander cuts in only one direction. When sanding with the grain of the wood, a drum or belt machine does not cut as aggressively as it does when it is sanding across the grain.

When sanding a surface where grain patterns differ, a drum or belt machine will dig into the cross-grain areas and leave the areas cut with the grain smoother and higher than the cross-grain.

To overcome this, cut at a 45-degree angle to the floor in two directions — the same as you would with a parquet floor. A third cut along the long dimension of the room must also be made, and you may also make a fourth pass, using a floor polisher and hard plate. Extra hand-sanding work may also be required.

Where grain pattern changes are limited to a small area — such as with medallions, borders or inlays — it is best to avoid using a drum or belt sander. Sand these areas with an edger, then with a floor polisher and sandpaper on a hard plate.

## Sanding metals

When sanding brass or other metals with a drum or belt sander, be aware that the metals will dull the abrasive, causing streaks in the sandpaper, which will show up in the wood.

Caution must be used when using an edger not to overheat the metal, which can burn the adjacent wood. If metal is protruding above the surface of adjacent wood, sand it flush with an edger using 50- or 60-grit paper.

Sand at short intervals and move to different areas, allowing the metal to cool. Otherwise, the metal will expand and break the bond between the epoxy and wood.

## Stone insets

Stone and marble insets may or may not be sanded with the wood flooring. Often, a plywood blank will be inserted in place of the marble or stone during the sanding phase. Once the sanding is completed, the blank will be removed and the marble or stone inset put in place.

Certain marbles can be sanded and finished at the same time the wood flooring is sanded and finished. The sanding process will remove the look of the pre-polished marble, so samples should be submitted to and approved by the customer.



*Stone and marble insets may or may not be sanded with the wood flooring. Often, a plywood blank will be inserted in place of the marble or stone during the sanding phase. Once the sanding is completed, the blank will be removed and the marble or stone inset put in place.*

## Finishing Ornamental Floors

While all phases of the installation, sanding and finishing of an ornamental hardwood floor are important, there is certainly no aspect more vital than the selection and application of the finish. The finish is what transforms the floor from a piece of sanded goods into a work of art.

It must be remembered that stain and finish color are strictly in the eye of the beholder. A client's verbal description of "medium brown" may be completely different from that of the contractor. The subjective nature of flooring finishes makes accurate sampling imperative.

The tendency for many species to change color over time (by oxidation), the varying color effects of different kinds of finishes, and even the degree of abrasives used on the last sanding of a floor make for many variables in the appearance of the finished custom floor. Therefore, it is best to prepare samples of the finished floor for the client to approve.

Note: Finishing floors that include multiple species of wood may require special finishing techniques. Many species accept stain differently than those you might be accustomed to working with, and some exhibit compatibility problems with different finishes. It is highly recommended that the flooring contractor consult with the distributors, manufacturers and mills of the specified woods, stains and finishes involved to ensure compatibility.

While the preparation of samples is a tedious process, it is the only way to convert the client's perceptions into a viable reference tool for the installer. It's a tool that can be used after the installation should there be any question as to whether the finished product matches the expectations of all parties involved.

Great care should be taken that all procedures of the proper sanding and finishing of hardwood floors be followed to the letter, from attention to system compatibility to education of the client in the maintenance of the finished floor.

# INDEX

<b>Apron/frame/skirting</b> .....	6, 7, 12, 16	<b>Marble</b> .....	11, 18, 20
<b>Basic layout</b> .....	12,	<b>Medallions</b> .....	7, 17
<b>Border</b> .....	3, 6, 8, 12, 13, 15, 16	<b>Metals</b> .....	11, 18, 20
dry laying .....	13	<b>Methods of installing</b> .....	14
placement .....	12	<b>Mitered corners</b> .....	7
width .....	8	<b>Mixed media</b> .....	3, 7, 11, 18, 20
<b>Building up the subfloor</b> .....	15	installing .....	18
<b>Calculating materials required</b> .....	12	sanding and finishing .....	20
<b>Continuous corners</b> .....	6, 7	<b>Ordering materials</b> .....	12
<b>Cutting allowance</b> .....	6, 12	<b>Parquet</b> .....	9
<b>Definitions</b> .....	6, 7	<b>Patterned floors</b> .....	7
<b>Design considerations</b> .....	8	<b>Plainsawn</b> .....	7, 10, 11
<b>Drawings and specifications</b> .....	8	<b>Preparing the floor for sanding</b> .....	16
<b>Dry laying</b> .....	13	<b>Quartersawn</b> .....	7, 10, 11
<b>Feature strip</b> .....	6	<b>Riftsawn</b> .....	7, 10, 11
<b>Field</b> .....	6, 8, 12, 15	<b>Sample preparation for color</b> .....	21
<b>Finger-block parquet</b> .....	6	<b>Sanding and finishing</b> .....	20
<b>Finish compatibility with wood species</b> .....	21	mixed media .....	20
<b>Finishing</b> .....	21	varied species .....	20
<b>Flooring grades</b> .....	10	varying grain direction .....	20
<b>Frame</b> .....	6	varying hardness .....	20
<b>Granite</b> .....	11	<b>Sanding metals</b> .....	20
<b>Hand-sanding</b> .....	20	<b>Sanding mixed media</b> .....	20
<b>Heartwood</b> .....	6, 10	<b>Sapwood</b> .....	7, 10
<b>Herringbone</b> .....	6	<b>Selecting materials</b> .....	10
<b>History of ornamental floors</b> .....	4	<b>Skirting</b> .....	7
<b>Inserting a spline/slip-tongue</b> .....	16	<b>Slip-tongue (spline)</b> .....	7, 16
<b>Installing borders with parquet fields</b> .....	16	<b>Spline (slip-tongue)</b> .....	7, 16
<b>Installing inlays and medallions</b> .....	17	<b>Stone</b> .....	11, 19, 20
dry laying .....	17	inserts during sanding and finishing .....	19, 20
finishing .....	17	<b>Style of the interior</b> .....	8
sanding .....	17	<b>Takeoffs (material requirements)</b> .....	12
use of router .....	17	<b>Tools</b> .....	5
use of templates .....	17	<b>Varying hardness</b> .....	20
<b>Installing mixed media</b> .....	18	<b>Wood species</b> .....	10
<b>Installing the apron</b> .....	16	changing color .....	21
<b>Installing the border</b> .....	15	compatibility with finishes .....	21
<b>Lapped corners</b> .....	6	natural colors .....	8
<b>Laser-cut</b> .....	6	rates of expansion and contraction .....	10
<b>Lighting</b> .....	9	sanding and finishing .....	20
		varying hardness .....	20
		<b>Wood species used in wood flooring</b> .....	10

# SOURCES AND CREDITS

## NWFA TECHNICAL MANUAL COMMITTEE

- John Hoopes, 3M Company, Chair
- Daniel Boone, NWFA Director of Technical Training
- Coley Armstrong, Basic Coatings
- Joe Audino, Rode Bros. Floors
- Don Bollinger, Wood Floor Products
- Jeff Buysse, Minuteman International
- Chris Coates, Golden State Flooring
- Don Conner, Harris-Tarkett
- Tom Conser, The Roane Company
- Bill Costello, Dura Seal
- Tom Derleth, Indiana Hardwood Specialists
- Galen Fitzel, 3M Company
- Jim Garth, Decorative Flooring
- John Goss, Woodwise/Design Hardwood Products
- Kevin Hacke, Maple Flooring Manufacturers Association
- Woody Hilscher, BonaKemi USA
- Mel Hollis, Basic Coatings
- Tim McCool, Cornerstone Flooring
- Mickey Moore, National Oak Flooring Manufacturers' Association
- Neil Moss, Robbins Hardwood Flooring
- Brian Roberts, Franklin International
- Bob Vanderlinden, Bruce Hardwood Floors

## PUBLICATION EDITORS AND CONTRIBUTORS

- Jim Garth, Decorative Flooring
- Taylor Hawley, The Bahr Co.
- Howard Brickman, Brickman Consulting
- Rick Brown, French-Brown Wood Floors
- Chuck Crispin, Legendary Hardwood Floors
- Tony Dovell, Bangkok International
- Jerry Jerski, W.W. Henry
- Eugene Klotz, Renaissance Floor In-Lays
- Steve Mitchell, Professional Coatings
- Mike Osborne, Laccrafter
- Tom Peotter, Historic Floors of Oshkosh
- Greg Rudolph, Rode Bros. Floors
- Hu Smithers, Precision Flooring Services
- John Stern, Kentucky Wood Floors
- Rick Berg, Kim Wahlgren and Katherine Williams  
*Hardwood Floors* magazine

## ART DIRECTOR/ILLUSTRATORS

- Michael Roberts, Jennifer Molander, and Amy Mazar  
*Hardwood Floors* magazine

## PHOTO AND ILLUSTRATION CREDITS:

- **Cover:** Photos of Stone Manor, a renovation of an 1800s structure in Lake Geneva, Wis. Owners: Drs. Nader Bozorgi and Mandan Farahati. Photos by Dale Hall Photography, Middleton, Wis.
- **Page 3:** Right, Stone Manor photo by Dale Hall Photography. Left, a recent installation in Houston. Photo courtesy of Greg Schenck, Schenck and Company, Houston.
- **Page 4:** Photo of the Hermitage, St. Petersburg, Russia, courtesy of BonaKemi USA.
- **Pages 6-7:** Illustrations by *Hardwood Floors* magazine, adapted from materials contributed by Joe Audino, Rode Bros. Floors, Los Angeles, and Jim Garth, Decorative Flooring, Marietta, Ga.
- **Page 8:** Photo by Michael Roberts, *Hardwood Floors* magazine.
- **Page 9:** Illustrations adapted from materials contributed by Kelly-Goodwin Company, Tukwila, Wash., and Rode Bros. Floors, Los Angeles.
- **Pages 10-11:** Illustrations by *Hardwood Floors* magazine, adapted from materials contributed by the National Oak Flooring Manufacturers Association and National Wood Flooring Association. Photo of wood species by Dale Hall Photography.
- **Pages 12-13:** Illustrations by *Hardwood Floors* magazine, adapted from materials contributed by Taylor Hawley, The Bahr Co., and Neil Moss, Robbins Hardwood Flooring.
- **Pages 14-17:** Illustrations by *Hardwood Floors* magazine.
- **Page 18:** Photo by Roger Turk, Northlight Photography, Port Orchard, Wash.
- **Page 19:** Ebony-padauk-brass photo by Don Bollinger, The Oak Floors of Greenbank, Seattle. Ebony-brass-red oak photo by Roger Turk, Northlight Photography, Port Orchard, Wash., courtesy of Taunton Press. Installation by The Oak Floors of Greenbank.
- **Pages 20-21:** Illustration by *Hardwood Floors* magazine, adapted from materials contributed by the National Oak Flooring Manufacturers Association. Photo of mixed media installation courtesy of Greg Schenck, Schenck and Company, Houston.

## THE FOLLOWING ORGANIZATIONS AND COMPANIES CONTRIBUTED MATERIALS AND INFORMATION TO THIS PUBLICATION:

- Dynamic Laser Applications
- Kelly-Goodwin Company
- National Oak Flooring Manufacturers Association
- Rode Bros. Floors